

This document is the property of Nian-Yeong Corporation and is delivered on the express condition that it is not to be disclosed, reproduced or used, in whole or in part, for manufacture or sale by anyone other than Nian-Yeong Corporation without its prior consent, and that no right is granted to disclose or to use any information in this document.

CUSTOMER DRAWING

REV.	DESCRIPTION	APPROVED BY	DATE	ECN NO.
A	RELEASE	Emily Suen	05/08/11'	
B	CHANGE MATERIAL	Emily Suen	16/09/22'	
C				
D				

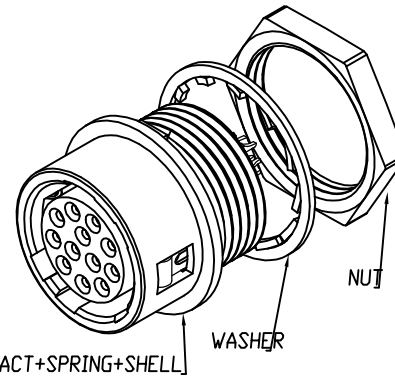
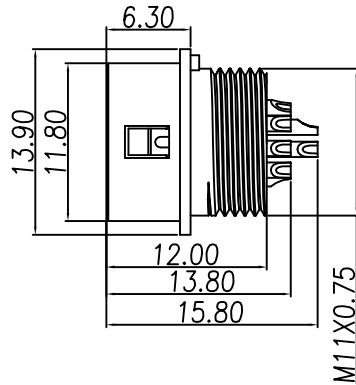
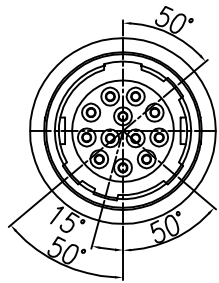

NOTE:

- MATERIAL :
 - 1-1. HOUSING : NYLON66 UL94V-0; COLOR : BLACK
 - 1-2. CONTACT : BRASS
 - 1-3. SHELL : ZINC ALLOY
 - 1-4. SPRING : STAINLESS STEEL
 - 1-5. WASHER : PHOSPHOR BRONZE
 - 1-6. NUT : BRASS
- FINISH :
 - 2-1. CONTACT : GOLD FLASH
 - 2-2. SHELL : NICKEL
 - 2-3. WASHER : NICKEL
 - 2-4. NUT : NICKEL
- ELECTRICAL SPECIFICATION :
 - 3-1. Rated current : 2A
 - 3-2. Rated voltage : 100V AC / 140V DC
- Environmental :
 - 4-1. Operation Temperature : -25°C~85°C

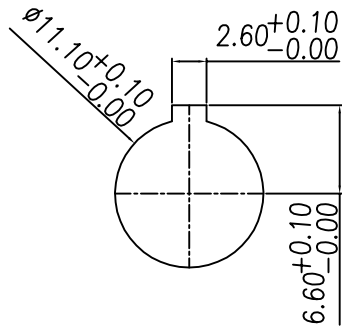

RECOMMENDED MOUNTING HOLE

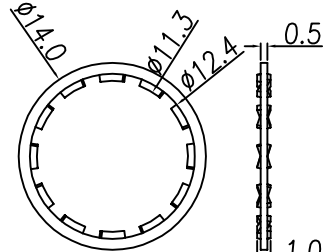

WASHER

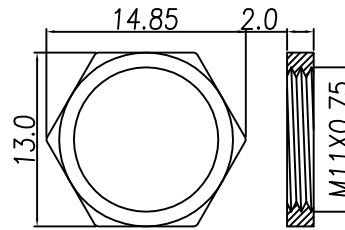

NUT

TABLE A

CONTACT ARRANGEMENT & DIMENSIONS(FRONT VIEW)

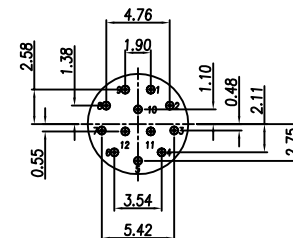

DI-12F2-02

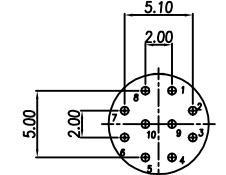

DI-10F2-03

DRAWN	Ku Chou	APPVL	Emily Suen	UNIT	mm	TOLERANCE			TITLE	DIN (F) 插座 (SHELL TYPE: RECEPTACLE)			SHEET
CHK'D	Emily Suen			SCALE	1:1					PART NO.	SEE TABLE A	DWG NO.	QC5555

NIAN YEONG ENTERPRISE
年永實業有限公司