

This document is the property of Nian-Yeong Corporation and is delivered on the express condition that it is not to be disclosed, reproduced or used, in whole or in part, for manufacture or sale by anyone other than Nian-Yeong Corporation without its prior consent, and that no right is granted to disclose or to use any information in this document.

CUSTOMER DRAWING

REV.	DESCRIPTION	APPROVED BY	DATE	ECN NO.
A				
B				
C				

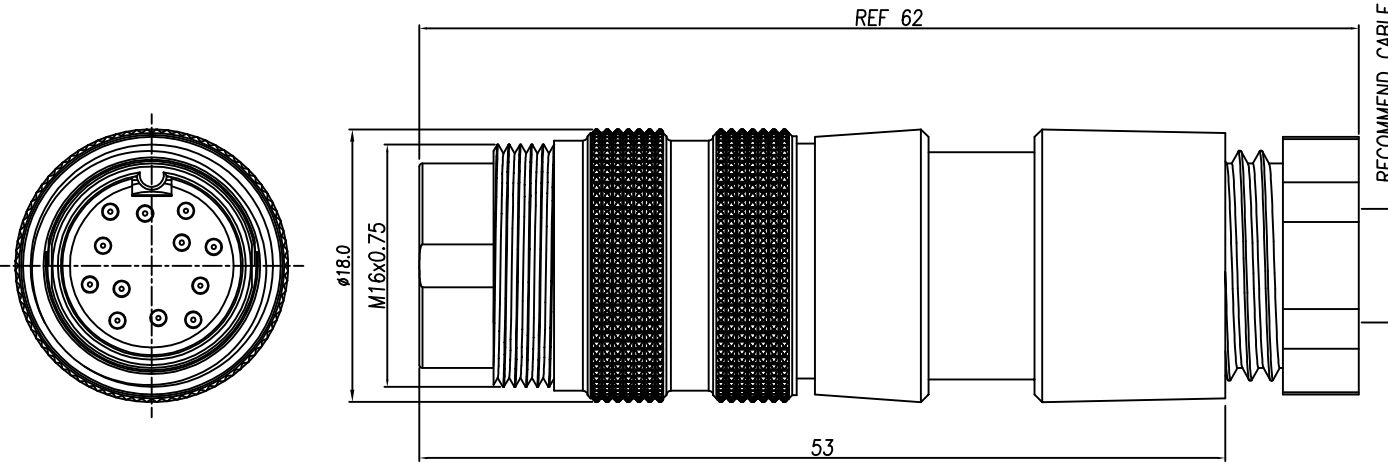

- MATERIAL :
  - 1-1. HOUSING : NYLON UL94V-0 ; COLOR : BLACK
  - 1-2. CONTACT : BRASS.
  - 1-3. CLAMPS BODY : ZINC ALLOY
  - 1-4. CAP : ZINC ALLOY
  - 1-5. ISOLATION : PVC
  - 1-6. CLAMPS : ZINC ALLOY
  - 1-7. SCREW : SPCC
  - 1-8. COAT : BRASS
  - 1-9. BACK BODY :NYLON+GF15% UL94V-0;COLOR:BLACK
  - 1-10. GLAND : SILICONE COLOR : BLACK
  - 1-11. GLAND CAGE :POM;COLOR:WHITE
  - 1-12. GLAND NUT :NYLON+GF15% UL94V-0;COLOR:BLACK
- FINISH :
  - 2-1. CONTACT : GOLD FLASH MICRO INCHES MIN.
  - 2-2. CLAMPS BODY : NICKEL PLATED
  - 2-3. CAP: NICKEL PLATED
  - 2-4. CLAMPS: NICKEL PLATED
  - 2-5. SCREW : NICKEL PLATED
  - 2-6. COAT : NICKEL PLATED
- ELECTRICAL SPECIFICATION :
  - 3-1. Rated current :3PIN~8PIN 5A ; 12PIN 3A
  - 3-2. Rated Voltage :3PIN~8PIN 250V ;12PIN 60V
  - 3-3. Water proof : IP40
- Environmental :
  - 4-1. Operation Temperature : -20 °C~85°C

DI-03M2-14-11	DI-04M2-23-11	DI-05M2-20-11	DI-05M2-22-11	DI-06M2-21-11	DI-07M2-21-11	DI-07M2-20-11	DI-08M2-22-11	DI-12M2-15-11

DRAWN	LED	APP'D	Ku Chou	UNIT	mm	TOLERANCE		TITLE	DIN (M) Assembly type			SHEET
CHK'D	Emily Suen			SCALE	1:1	.x ±0.20 .xx ±0.10 .xxx ±0.05 .xxxx ±0.03 ANGULA ±1°		PART NO.	SEE TABLE A	DWG NO.	QC9242	1/3 VERSION A

NIAN YEONG ENTERPRISE  
年永實業有限公司

This document is the property of Nian-Yeong Corporation and is delivered on the express condition that it is not to be disclosed, reproduced or used, in whole or in part, for manufacture or sale by anyone other than Nian-Yeong Corporation without its prior consent, and that no right is granted to disclose or to use any information in this document.

# CUSTOMER DRAWING

REV.	DESCRIPTION	APPROVED BY	DATE	ECN NO.
A				
B				
C				

## ASSEMBLY INSTRUCTION

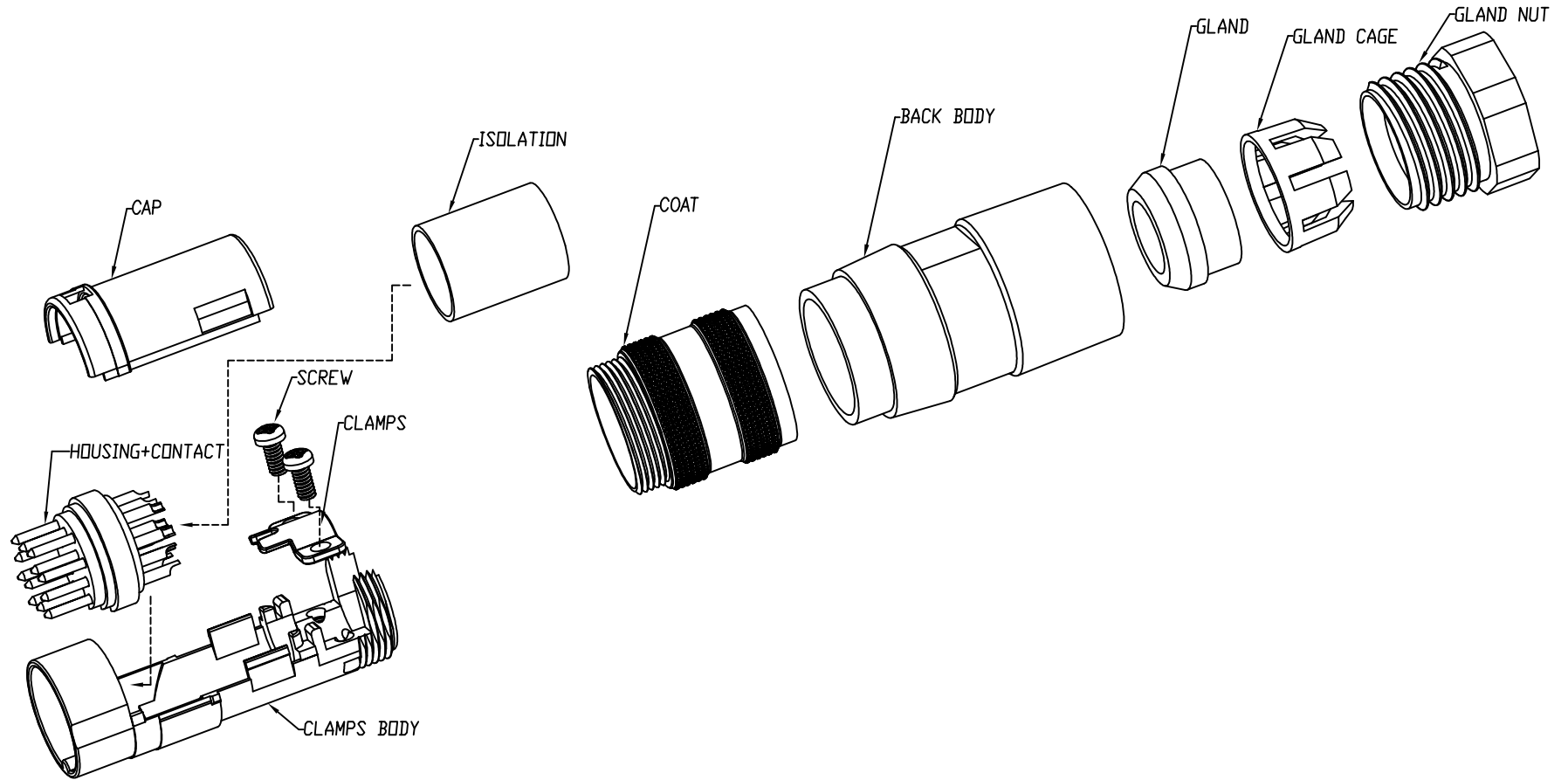

DRAWN	LED	APP'D	Ku Chou	UNIT	mm	TOLERANCE		TITLE	DIN (M) Assembly type			SHEET
CHK'D	Emily Suen			SCALE	1:1	.x ±0.20 .xx ±0.10 .xxx ±0.05 .xxxx ±0.03 ANGULA ±1°		NIAN YEONG ENTERPRISE 年永實業有限公司	PART NO.	SEE TABLE A	DWG NO.	QC9242

This document is the property of Nian-Yeong Corporation and is delivered on the express condition that it is not to be disclosed, reproduced or used, in whole or in part, for manufacture or sale by anyone other than Nian-Yeong Corporation without its prior consent, and that no right is granted to disclose or to use any information in this document.

# CUSTOMER DRAWING

REV.	DESCRIPTION	APPROVED BY	DATE	ECN NO.
A				
B				
C				

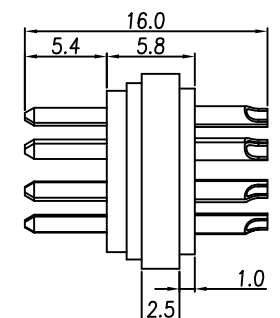
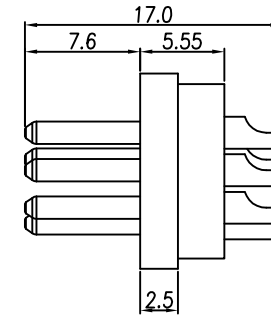
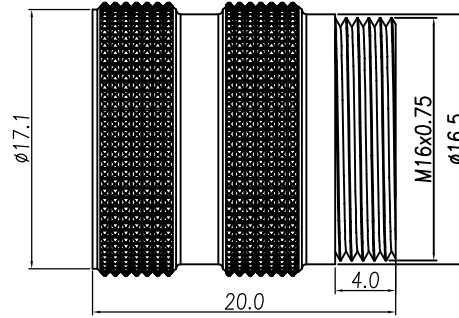
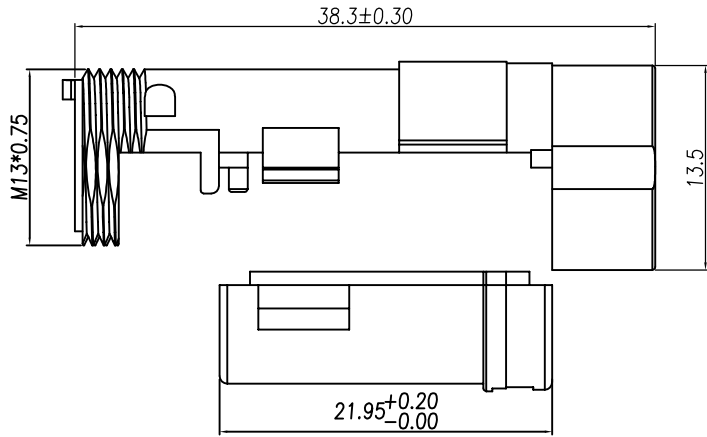

3P~8PIN尺寸

12PIN尺寸

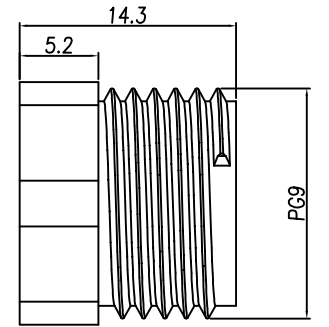
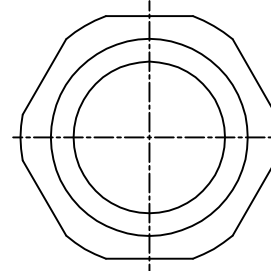
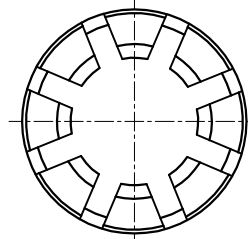
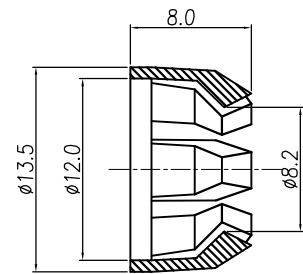
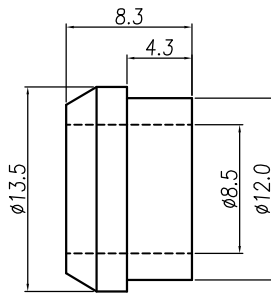
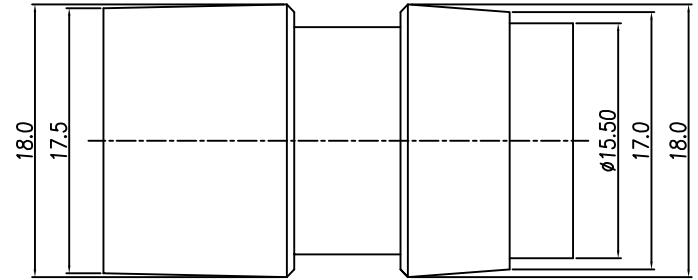
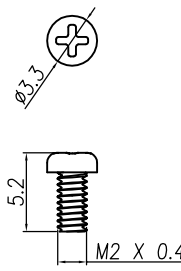
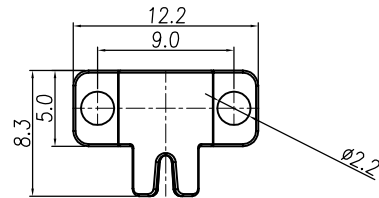
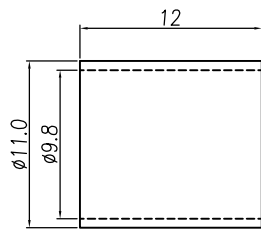

DRAWN	LED	APP'D	Ku Chou	UNIT	mm	TOLERANCE		TITLE	DIN (M) Assembly type			SHEET	
CHK'D	Emily Suen			SCALE	1:1	.x ±0.20 .xx ±0.10 .xxx ±0.05 .xxxx ±0.03 ANGULA ±1°		年永實業有限公司	PART NO.	SEE TABLE A	DWG NO.	QC9242	3/3
												VERSION	A