

This document is the property of Nian-Yeong Corporation and is delivered on the express condition that it is not to be disclosed, reproduced or used, in whole or in part, for manufacture or sale by anyone other than Nian-Yeong Corporation without its prior consent, and that no right is granted to disclose or to use any information in this document.

CUSTOMER DRAWING

REV.	DESCRIPTION	APPROVED BY	DATE	ECN NO.
A	RELEASE	Yeh Chou	2017/xx/xx	
B				
C				
D				

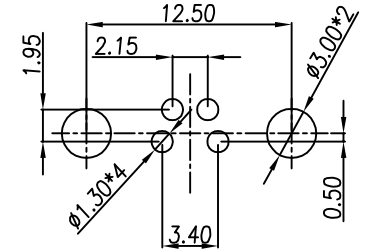
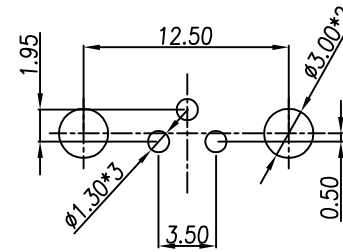
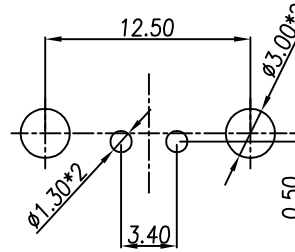
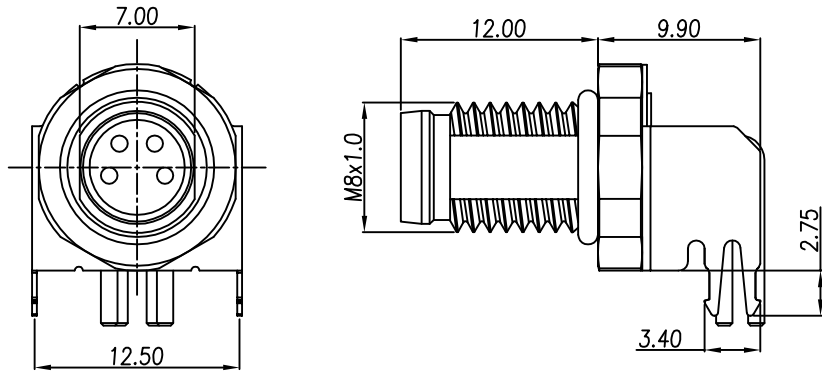

P.C.B LAYOUT

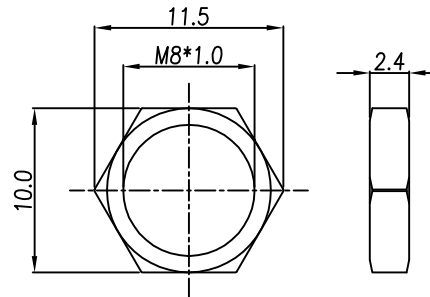
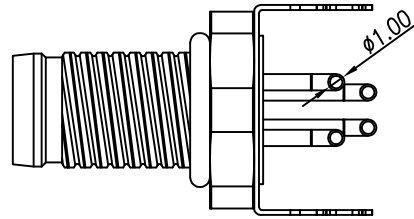

NUT

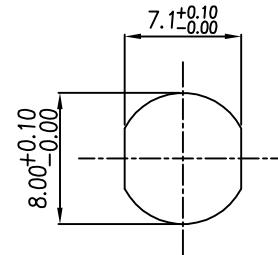

RECOMMEND PANEL CUT-OUT

TABLE A / 表A

WP-02M3-04-11	WP-03M3-06-11	WP-04M3-05-11

PIN ASSIGMENTS
FRONT VIEW

- MATERIAL :
 - 1-1. HOUSING : PA UL94V-0 ; COLOR : BLACK
 - 1-2. CONTACT : BRASS.
 - 1-3. NUT : BRASS.
 - 1-4. SHELL : BRASS.
 - 1-5. O-RING : NBR
 - 1-6. GROUND : PHOSPHOR BRONZE
- FINISH :
 - 2-1. CONTACT : 10 MICRO INCHES MIN. GOLD PLATED
UNDER PLATE : NICKEL
 - 2-2. NUT : NICKEL PLATED
 - 2-3. SHELL : NICKEL PLATED
 - 2-4. GROUND : BIRGHT TIN PLATED
- ELECTRICAL SPECIFICATION :
 - 3-1. Rated current : 4A
 - 3-2. Rated voltage : 60V
 - 3-3. Water proof : IP67 When Un-mated
- Environmental :
 - 4-1. Operation Temperature : -40°C~85°C

DRAWN	Yeh Chou	APPVL	Ku Chou	UNIT	mm	TOLERANCE			TITLE	Waterproof M8 (M) 前鎖 90° DIP+接地			SHEET	
CHK'D	Emily Suen			SCALE	1:1	.x ±0.20 .xx ±0.10 .xxx ±0.05 .xxxx ±0.03 ANGULA ±1°			PART NO.	SEE TABLE A	DWG NO.	QC8471	VERSION	

NIAN YEONG ENTERPRISE
年永實業有限公司